

High Precision Torque Sensor for non-rotating applications

MODEL 8630

NEW

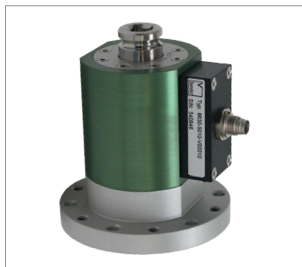

Model 8630 Flange-mounted



Model 8630 Bracketed-mounted

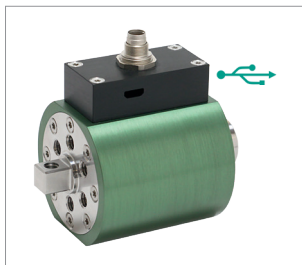

Model 8630 with USB interface

Highlights

- Measuring ranges from 0 ... 2 N·m up to 0 ... 200 N·m
- Linearity error $\leq 0,1$ % F.S.
- Internal square and external square
- Standardized output signal
- Tare function, filter and average values configurable
- Insensitive to side loads thanks to built-in support bearing

Options

- Output signal ± 10 V / USB
- burster TEDS
- Bracket or flange adapter offers choice of mounting options
- Dual-range model

Applications

- Testing screw-fastening tools
- Logging data for specified release torques
- Measuring the tightening torque of screw connections
- Acquisition of breakage moments on screw caps

Product description

This high-precision torque sensor can be used to perform both static and dynamic measurements on non-rotating parts. The internal and external square drive design make this sensor especially easy to fit in existing or new screw-fitting applications.

Quality assurance and monitoring of screw-fastening tools are just two applications that can take full advantage of sensor features such as USB port, built-in amplifier and side-load absorbing bearings.

With no rotating parts, this sensor needs no maintenance when used correctly.

Available accessories include mounting brackets and flange adapters, which enable quick, easy and practical integration of the sensor into existing or newly developed setups and test benches.

The strain-gauge based sensor's modular design allows precise configuration for the desired application.

With the integrated amplifier option, the sensor directly supplies a voltage signal of 0 ... ± 10 V that is proportional to the torque. The sensor can be configured via the micro-USB interface, providing access to, for example, a filter frequency setting, averaging, and a tare function. Measurements via USB in addition to the voltage output are available with the USB measurement option. The sensor comes with the DigiVision software for performing measurements and data archiving, with drivers additionally available e.g. for LabVIEW. Integration into custom software is possible via DLL. Examples can be found on our website www.burster.com

The burster TEDS option (electronic data sheet, memory chip with sensor-specific data) allows rapid configuration of compatible evaluation units (instrumentation amplifier, indicator, ...).

Technical Data

8630	-	5002- VXXXXX	5005- VXXXXX	5010- VXXXXX	5020- VXXXXX	5050- VXXXXX	5100- VXXXXX	5200- VXXXXX
Measuring range calibrated in N·m from 0 ...		±2	±5	±10	±20	±50	±100	±200
Higher measuring ranges on request.								
Accuracy								
Relative non-linearity		0.1 % F.S.						
Relative hysteresis		0.1 % F.S.						
Tolerance of sensitivity		0.1 % F.S.						
Maximum axial load	[N]	800	1000	1500	5000		7000	
Maximum radial load	[N]	300			550		750	
Spring constant	[N·m/rad]	6	7	11	23		20	
Mass moment of inertia measuring side	[10 ⁻⁶ kg·m ²]	0,57	0,73	0,9	12,15	13,7	44,7	51,66
Electrical values without amplifier / USB								
Bridge resistance (full bridge)		1000 Ω						
Excitation voltage		5 V						
Max. excitation voltage		10 V						
Environmental conditions without amplifier / USB								
Range of operating and nominal temperature		-20 °C ... +80 °C						
Sensitivity of temperature effects		at zero 0.015 % F.S./K on final value 0.010 % F.S./K						
Electrical values with amplifier/USB								
Rated supply voltage range		5 ... 30 V DC (or 5 V via USB)						
DC power consumption		approx. 1 W						
Output voltage at ± rated torque		±10 V						
Output resistance		<500 Ω						
Insulation resistance		zero (binding capability)						
-3 dB cut-off frequency		5000 Hz						
Ripple		<50 mV _{ss}						
Calibration signal		10.00 V DC						
Environmental conditions with amplifier/USB								
Range of operating and nominal temperature		-20 °C ... +60 °C						
Sensitivity of temperature effects		at zero 0.015 % F.S./K on final value 0.010 % F.S./K						
Mechanical values								
Dynanic overload safe		up to 70 % from nominal value						
Max. operation torque ≥0,2 N·m		150 % of nominal torque						
Breakaway torque		300 % of nominal torque						
Alternating load		70 % of nominal torque						
Other		5002	5005	5010	5020	5050	5100	5200
Material:		Housing: made of anodized aluminium Shaft: steel shell 1.4542						
Protection class		acc. EN 60529, IP40						
Weight	[g]	139			219		354	

Geometrie

8630	-	5002-VXXXXX	5005-VXXXXX	5010-VXXXXX	5020-VXXXXX	5050-VXXXXX	5100-VXXXXX	5200-VXXXXX
L	[mm]		66			80		100
L2	[mm]		48			55		65
H	[mm]		47			63		79
ØJ	[mm]		40			55		70
LK	[mm]		20			25		41
A	[mm]		6.3 (1/4")			10 (3/8")		12.5 (1/2")
G	[mm]		M4			M6		M8
Mounting								
Mounting instructions	Do not exceed the permitted axial and radial forces during fitting and operation (see technical data). Please refer to our operating instructions for detailed information www.burster.com . Do not use the housing as a means of absorbing torque.							

Dimensional drawing 1 **Model 8630**

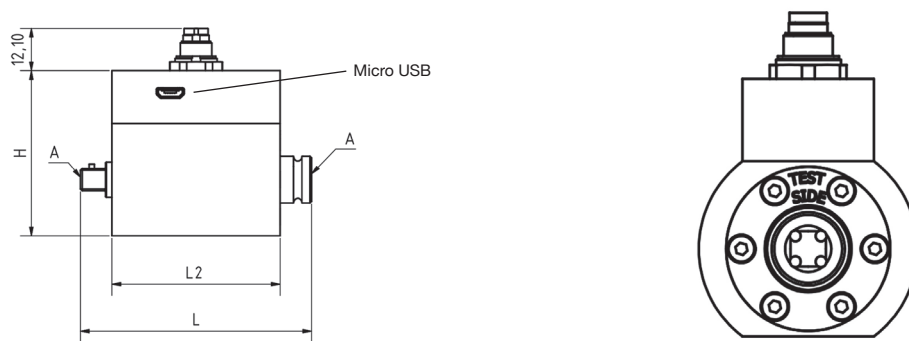

Dimensional drawing 2 **Model 8630**

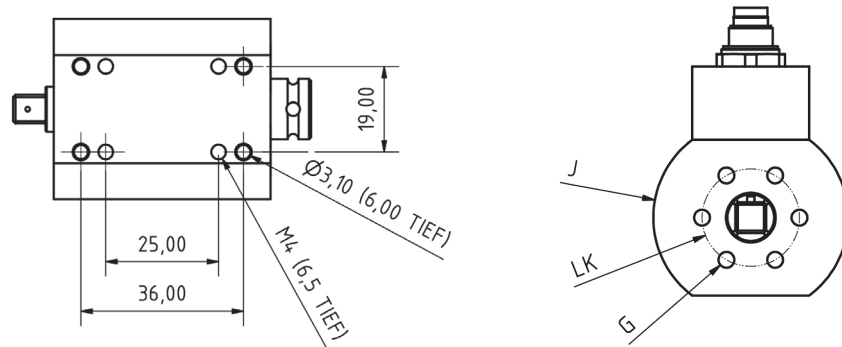

Holes on the sensor underside only up to 10 N.m. For detailed dimensions, including with fitted flange or bracket, you can find sensor CAD data on our website www.burster.com.

Electrical values

7-pin miniature connector, additionally micro-USB interface for configuration/measurement (Option, USB connection cable included)

Wiring Code depends on the options selected

Pin	Assignment without electronic	Assignment with electronic
1	Bridge supply -	Supply GND
2	Bridge supply +	Supply +5 ... 30 V
3	Shield	Shield
4	Signal +	Output signal ±10 V
5	Signal -	Output signal GND
6	TEDS I/O (option) / NC	Control signal
7	TEDS GND (option) / NC	Switching between ranges (option)

Flange-mounted model

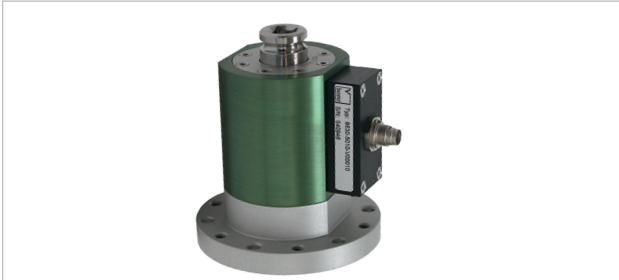

The flange adapter allows easy integration of the sensor in existing equipment with a flange connection. When ordered with the sensor, the flange adapter comes pre-fitted; please refer to order code.

Alternatively it can be ordered separately as an accessory.

Please refer to the accessories data sheet 8600-Z00X.

Bracket-mounted model



The bracket provides a quick-to-fit and stable fixture for the sensor. When ordered with the sensor, the bracket comes pre-fitted; please refer to order code.

Alternatively it can be ordered separately as an accessory.

Please refer to the accessories data sheet 8600-Z001.

Torque sensor with built-in USB port (option)

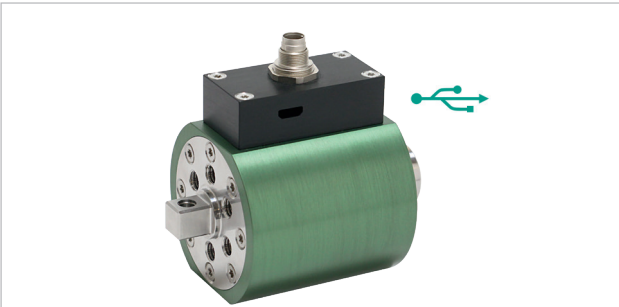

This sensor model comes with a USB port in addition to the 0 ... ± 10 V output. Two versions are available:

- ± 10 V output signal, USB used solely for configuration
- ± 10 V output signal, USB used for both configuration and measurement

When a USB-based measurement is launched, the analog output signal is disabled because it is not possible to use both forms of output simultaneously.

With both versions, the measurement signal can be tared, averaged or filtered. These functions can be set up and/or activated via USB and the free version of DigiVision.

Dual-range version



With integrated amplifier, the dual-range option can be selected. The following subdivisions are available:

Graduation:	1:2	1:4	1:5
	Upper scale value of second range		
2 N·m	1 Nm	0.5 Nm	-
5 N·m	-	-	1 Nm
10 N·m	5 Nm	-	2 Nm
20 N·m	10 Nm	5 Nm	-
50 N·m	-	-	10 Nm
100 N·m	50 Nm	-	20 Nm
200 N·m	100 Nm	50 Nm	-

The second, smaller measuring range can be activated via USB or by applying the operating voltage to pin 7.

DigiVision configuration and analysis software

Features

- Can be used to actuate tare function, with value stored in sensor
- Configuration options for averaging and filters; value stored in sensor
- Intuitive user interface
- Automatic sensor identification
- Sensor calibration data readout

DigiVision Light PC software

DigiVision configuration and analysis software max. 200 measured value/s for one sensor (freely available on our website)

DigiVision Standard PC software

DigiVision configuration and analysis software up to 16 channels Model 8630-P100

PC-Software DigiVision Professional

DigiVision configuration and analysis software including maths functions; up to 32 Model 8630-P200

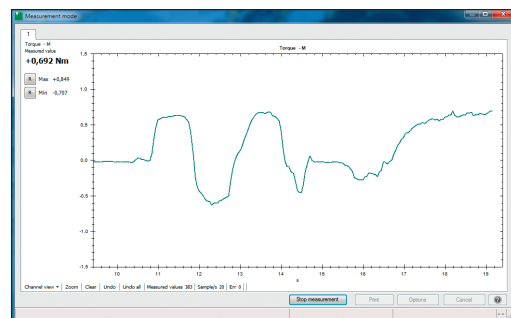

USB measurement option

- Numerical & graphical display and measurement of the physical torque value
- Practical start and stop trigger functions
- 4 limits can be configured for each measurement channel
- MIN/MAX value acquisition
- Automatic scaling
- Measurement reports can be saved as Excel or PDF file
- Archive viewer for displaying sets of curves
- X Multichannel measurements, even with different sensors (e.g. 9206, 8631, 8661) available with standard version

Accessories

Order code	
9900-V594	Mating connection 7 pin
9900-V596	Mating connection 90°-angle
99594-000A-0150030	Connecting cable, length 3 m, other end free
99596-000A-0150030	Connecting cable, length 3 m, plug with 90°-angle, other end free
99141-594A-0150030	Connecting cable for burster desktop instruments with 12 pin socket, length 3 m
99209-586C-0510030	Connecting cable for model 9235, model 7281 and model 9311, length 3 m
9900-K358	Micro USB cable, length 1.8 m
8630-Z003	Adapter internal square - internal square 1/4"
8630-Z004	Adapter internal square - internal square 3/8"
8630-Z005	Adapter internal square - internal square 1/2"
8630-Z006	Adapter external square - external square 1/4"
8630-Z007	Adapter external square - external square 3/8"
8630-Z008	Adapter external square - external square 1/2"
8630-P100	DigiVision Standard configuration and analysis software; up to 16 channels
8630-P200	DigiVision Professional with additional configurable maths channel; up to 32 channels
	DigiVision Light configuration and analysis software, max. 200 measured value/s for one sensor (freely available on our website)
8600-Z00X	Flange-mounted or Bracket-mounted, see accessories data sheet 8600-Z00X

Calibration

Manufacturer Calibration Certificate (WKS)	
	Special calibration for clockwise or/and counter clockwise direction torque, in 20 % steps of range up and down.
DAkkS Calibration Certificate	
	DAkkS calibration certificate per DIN 51309, clockwise and/or anticlockwise torque, with eight steps spaced across the measurement range, increasing and decreasing.

Order Code

Measuring Range		Code			
0 ... ±2 N·m		5	0	0	2
0 ... ±5 N·m		5	0	0	5
0 ... ±10 N·m		5	0	1	0
0 ... ±20 N·m		5	0	2	0
0 ... ±50 N·m		5	0	5	0
0 ... ±100 N·m		5	1	0	0
0 ... ±200 N·m		5	2	0	0

											Standard				
											0	0	0	1	0
8	6	3	0	-	X	X	X	X	-	V		0			0
Standard sensor															
■ Standard sensor, one measuring range											0				
■ Dual-range version, graduation 1:5 from measuring range 5 N·m											2				
■ Dual-range version, graduation 1:4											3				
■ Dual-range version, graduation 1:2											4				
Output signals															
■ Output voltage 10 V incl. configuration USB											0				
■ Output voltage 10 V incl. USB configuring and measuring USB											1				
■ Output signal standardized, mV/V											3				
■ Output signal standardized, mV/V with TEDS											4				
Versions															
■ Internal square/External square											1				
■ Internal square/Flange-mounted											5				
■ Internal square/incl. Bracket-mounted											6				